



# ÇELİKLER

ALÜMİNYUM PLASTİK SAN. VE TİC. A.Ş.

## AHŞAP DOĞRAMA PROFİLLERİ

web: [www.celikleraluminyum.com.tr](http://www.celikleraluminyum.com.tr)  
email: [celikler@celikleraluminyum.com.tr](mailto:celikler@celikleraluminyum.com.tr)



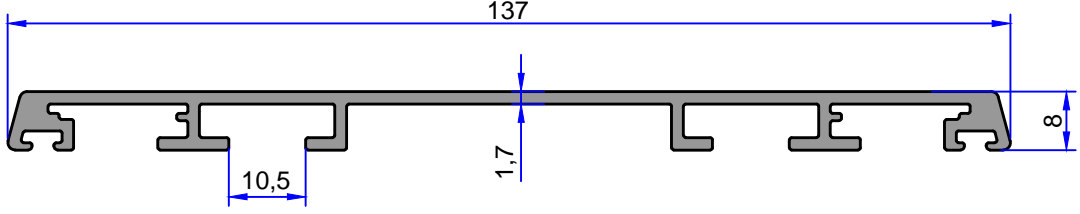

**5702**  
1.034 kg/m

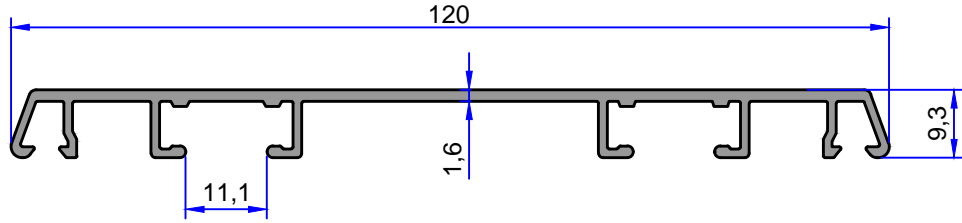

**5867**  
0.787 kg/m

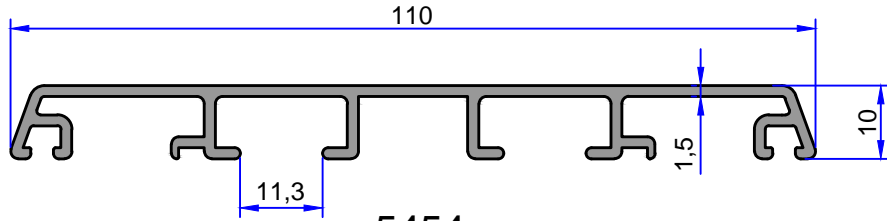

**5454**  
0.819 kg/m

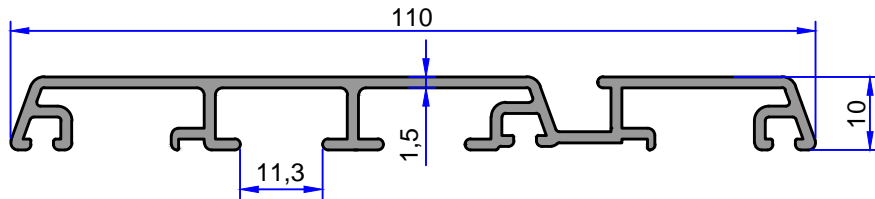

**5453**  
0.866 kg/m

## AHŞAP DOĞRAMA PROFİLLERİ

ÇELİKLER  
ALÜMİNYUM PLASTİK  
SAN.VE TİC. A.Ş.

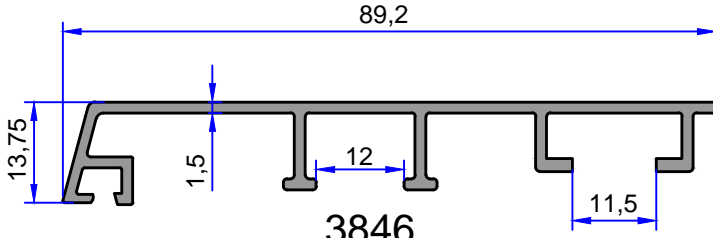

**3846**  
0.667 kg/m

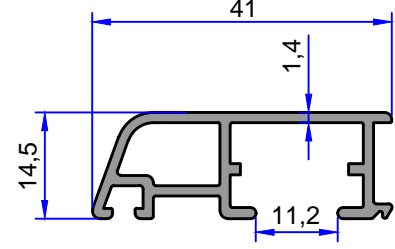

**5452**  
0.416 kg/m

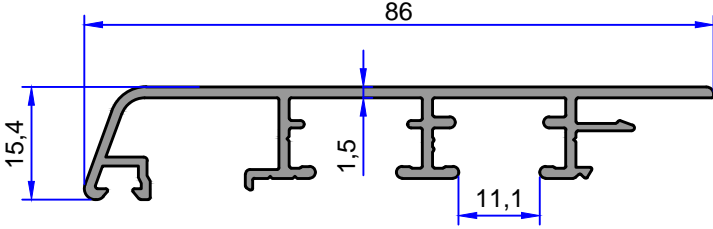

**5866**  
0.685 kg/m

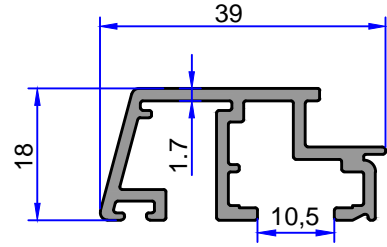

**4445**  
0.494 kg/m

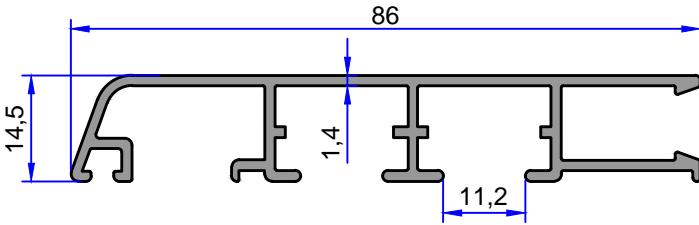

**5451**  
0.737 kg/m

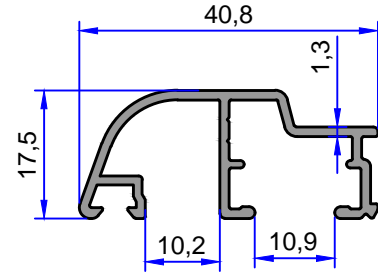

**5868**  
0.368 kg/m

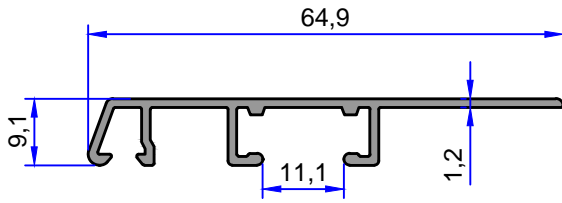

**5865**  
0.351 kg/m

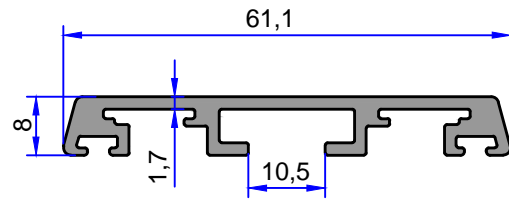

**4942**  
0.576 kg/m

Not: Katalog ağırlıkları teorik ağırlıklardır. Üzerine kalıp aşınmasından dolayı %3-%5 boya farkından dolayı %4-%6 ağırlık ilave edilecektir.

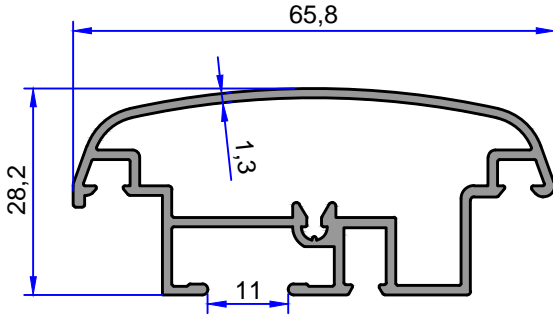

**5869**  
0.788 kg/m

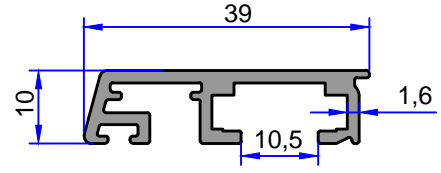

**5701**  
0.394 kg/m

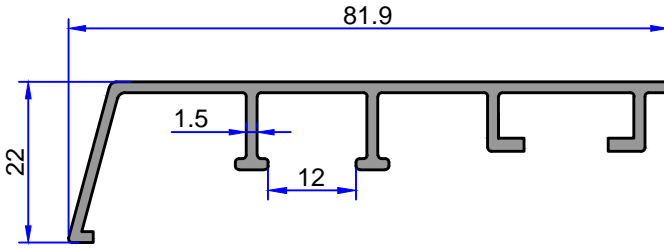

**3793**  
0.612 kg/m

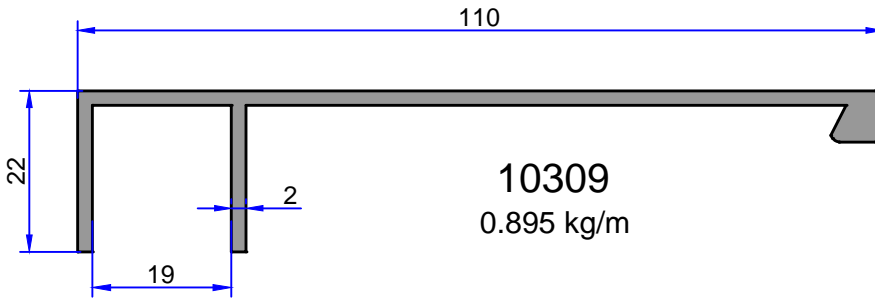

**10309**  
0.895 kg/m

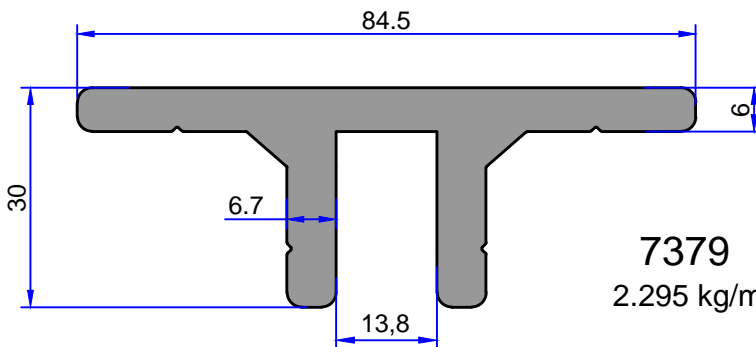

**7379**  
2.295 kg/m

